

# *THE MISSOURI DESIGNED MASONRY STOVE*

*FUEL EFFICIENT  
HOME HEATING. . .*

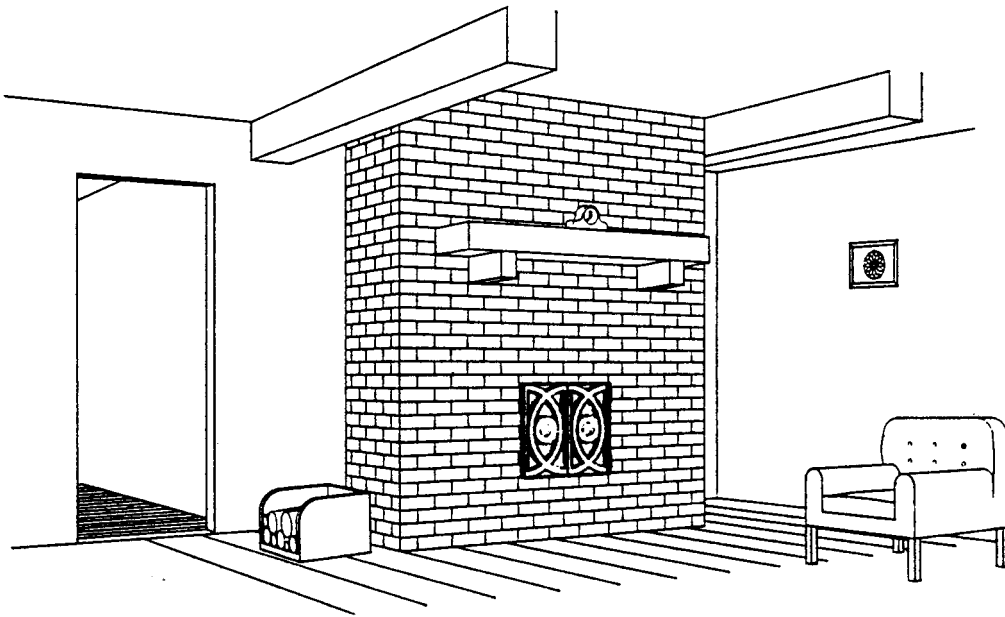









*WITH WOOD*

**Energy  
Extension  
Service**



MISSOURI DEPARTMENT OF NATURAL RESOURCES

This publication was prepared with the support of funds from the United States Department of Energy (U.S.DOE), under Grant #G-87-23-EOO-22 and was compiled and edited by the Missouri Department of Natural Resources' Division of Energy (MO DNR/DE). However, any opinions, findings, conclusions, or recommendations expressed herein under the individual organizational entries are those of the organization! and do not necessarily reflect those of either the U.S. DOE or MO DNR/DE.

LEGEND	
ORNAMENTAL BRICK =	
FIREBRICK =	
SKEW FIREBRICK =	
ARCH FIREBRICK =	
IRON MEMBERS =	
FLUE TILE =	
CONCRETE =	
AIR FLOW =	
ALL DIMENSIONS IN DECIMAL INCHES	

# Introduction

The Missouri Designed Masonry Stove booklet was published with funds supplied by the US. Department of Energy. Special recognition is to be given Norman Lenhardt of the Missouri Department of Natural Resources' Division of Energy for his extensive research, drafting, and editing of the content. Art Foell, Industrial Technology senior at Southwest Missouri State University (SMSU), refined many of the graphics in the Harris Computer Center at SMSU. Linn Sunderland, of Southeast Community College, Beatrice, Nebraska, also supplied information. The manual was conceived in response to a slow but steady increase of requests for information about masonry stoves ("Russian" fireplaces). General information and conceptual information has been available for the past few years in popular magazines. However, there seemed to be only a limited amount of in-depth information on how to build and operate a masonry stove, even though a few organizations have supplied information to their members.

Many of these information sources have been reviewed. While these sources were helpful, they all seemed to be incomplete within themselves, also most of the stoves (as described) were too large for most homes. For this reason, it was decided to try to publish a more comprehensive write-up with suggested drawings and construction details.

PHONE: (314)751-4000

# Table of Contents

Introduction . . . . .	i
The Missouri Designed Masonry Stove . . . . .	1
Reasons for Building . . . . .	2
Construction of a Masonry Stove . . . . .	<b>2</b>
HearthPad . . . . .	2
Combustion Air . . . . .	4
Combustion Air Intake . . . . .	4
Combustion Air Valve . . . . .	5
Brick and Mortar Suggestions . . . . .	5
Specialized Brick . . . . .	7
Flue and Chimney . . . . .	7
Avoid Downdrafts . . . . .	8
Damper . . . . .	8
Construction Time . . . . .	8
Doors and Cleanouts . . . . .	8
Sealing the Cleanouts . . . . .	9
Size of unit . . . . .	9
Placement of Unit . . . . .	9
Maintaining Air Space . . . . .	<b>9</b>
Gaskets . . . . .	10
Operating the Masonry Stove . . . . .	11
Start-up Conditioning . . . . .	11
Loading Wood . . . . .	11
Operating (Controlling the Fire) . . . . .	11
Fuel Types . . . . .	11
Heat Distribution . . . . .	12
Safety . . . . .	12
Installation of Gas Port . . . . .	13
BuilderdCrafter's Confidence . . . . .	14
References . . . . .	14
Materials List . . . . .	14
Tools Required . . . . .	18
Construction Details . . . . .	20

# The Missouri Designed Masonry Stove

At last there is an energy efficient replacement for the popular, but energy inefficient English style fireplace. This style fireplace or masonry stove is based on the very simple concept of storing heat in a series of brick baffles for longer, slower release as opposed to sending heat up the chimney of the standard fireplace.

With imagination, these masonry stoves, sometimes referred to as “Russian” fireplaces, can be very attractive and functional. Progressive home buyers and builders may want to consider one of these efficient units as a substitute for the older inefficient open-style fireplaces. Innovative crafters can devise many ways to make these units just as decorative as other heating units. Considering the long-term world energy situation, it makes sense to utilize the best possible heating devices in your home.

The masonry stove is a highly efficient heating unit which has been used in Eastern Europe for hundreds of years. Once widely used in the western and northern parts of the mid-west, lower cost heating units and more convenient fuels ultimately resulted in the decline, and finally abandonment of these masonry stoves. High cost fuels and the impending scarcity of oil and natural gas, have stimulated a renewed interest because of the lower cost of operation compared to other types of fireplaces or fireplace inserts. This ninety (90) percent efficient stove design was reintroduced by a Russian immigrant which accounts for the commonly used name of “Russian” fireplace.

This masonry stove is based on the use of flue baffles made of brick, stone or adobe, that direct the hot flue gases in an “S” shaped pattern. The serpentine pattern slows down the air speed and also increases the length of the flow. Each additional square foot of masonry surface absorbs some of the heat from the flue gas until maximum available temperature is reached. As the fire itself is allowed to bum out, the hot bricks slowly pass their stored heat through the wall and into the living space as radiant heat. Each pound of brick will store 2/10 BTU of energy for each degree (Fahrenheit) rise in temperature. This is the reason a masonry stove is so efficient and retains heat for long periods.

This slow, steady, low-level heat is very comfortable, much more so than a fan-driven, central heated, hot air furnace. The appearance of this type fireplace is controlled mostly by the designer’s imagination, time and skill in constructing the unit. It is possible to design one of these units to resemble an English style fireplace, but it adds greatly to the time, cost and complexity, and serves to perpetuate an appearance of an outdated fireplace that was never well designed for home heating.

On a cold day, the standard widemouth deep firebox, English style, masonry fireplace will lose more furnace heated air up the chimney than it generates from the fuel it bums. Under the best of conditions, the English fireplace will waste ninety (90) percent of the fuel that it burns on a season long basis. By contrast the masonry stove has been tested and found to deliver to the room, about ninety (90) percent of the heat generated from the fuel that is consumed. Even the least efficient masonry stove designs have resulted in eighty (80) percent of the heat delivered to the living space, compared to sixty (60) to sixty-five (65) percent for many of the airtight modem wood stove designs.

The Missouri designed masonry stove, as shown in the drawings, will cost about the same amount as the standard English fireplace, but will have a lower life cycle cost because it uses fuel so efficiently. One full loading of the firebox of a masonry stove will keep the stove at comfortable temperatures for 24 to 36 hours. These massive brick or masonry units work very well as part of the heat storage mass for passive solar heated homes. The units can also be used as room dividers.

Masonry stoves are very well adapted to new homes where floor plans allow for the required extra space. They can be adapted to many existing homes by locating the unit in an insulated basement or in the living room by the use of reinforced masonry piers. In some cases, a slab on grade floor may carry the weight if properly reinforced. These adaptations will increase the cost of the unit, but generally will be cost effective over time, because of the fuel cost savings that result.

## Some Reasons for Building a Masonry Stove

### Advantages

01. The cost is similar to the English style fireplace.
02. Masonry stoves use much less fuel; sometimes up to thirty (30) percent less than the best steel stoves.
03. The units may be used as part of the mass heat storage for passive solar systems.
04. Masonry stoves provide more comfortable heat than hot air or baseboard heat.
05. Masonry stove owners report greater personal comfort at lower room temperatures.
06. When properly operated, these units have reduced creosote buildup.
07. Masonry stoves generate less pollution, by sending less fly ash and unburned gases up the chimney and into the atmosphere.
08. The unit can be adapted for the heating of domestic hot water.
09. The unit can contain a built-in oven.
10. Masonry stoves can be designed to load fuel from either side or either end.
11. Residential floor plans may be designed to permit loading the unit from an isolated hall or mud room.
12. Masonry stoves costs only slightly more than a high quality stove and chimney.
13. Masonry stoves can be designed and situated to occupy less space than some of the larger radiant style steel stoves because they can be set closer to walls, etc. (do not neglect safety clearances).

### Disadvantages

01. Masonry stoves take up more room than most stoves or wall mounted fireplaces. However, by using specialized firebrick or castable fire clay it may be possible to have a masonry stove with a 25" x 25" exterior ornamental wall dimension.
02. The units may be difficult to retrofit to an existing residence.
03. Masonry stoves warm up slowly, unless a hot water radiator or oven has been designed into the unit.
04. Specialized masonry materials are difficult to find in some locales.

## Construction of a Masonry Stove

The following pages will include years of accumulated construction and design ideas. The construction procedure will be illustrated, starting with the reinforcement of the hearth pad.

### Hearth Pad

The hearth pad is the lowest part of the fireplace on which the firebox is constructed. The pad should be reinforced with 3/8 inch reinforcement rods (rebar or rerods) on 18 inch centers in both directions. The rods should be centered under the firebox (firebrick) and the ornamental brick safety wall to avoid cracking the structure due to slight shifts in the substructure. Hairline cracking of the pad can be reduced by the use of 2" x 4" welded wire fence mesh, wired to the reinforcement rod with soft steel wire or baling wire.

The pad should always rest on well tamped ballast for new construction. The base must be of sufficient size to carry the load of the masonry stove as determined by soil type at the construction site. The load is approximately 7 to 8 pounds per square inch or 1008 to 1152 pounds per square foot. The size of masonry stove featured in this publication, including the pad, will weigh about 11,000 pounds and contains approximately 400 firebrick and 550 ornamental bricks plus the mortar. Tile or additional ornamentation will increase this weight. This amount of material is adequate to build a masonry stove for a small single story residence with eight foot ceilings and a five foot attic to gable. Note: a pad is not necessary if the stove is set on a reinforced slab on grade. Firebrick must protect the pad or the slab floor. A pad does add to the decor, making the unit easier to load and/or clean the masonry stove, and also simplifies the intake air ducting, unless a new floor slab, including air ducting, is being poured.

In the concrete hearth pad, use 1/2 inch diameter clean silicon gravel and clean silicon sand, drinking clarity water and enough type A1 portland cement (available at lumber yards) to handle the weight of the structure. Do not use limestone aggregate in the hearth pad, because it expands from heat and pops out of the slab. Five or six bags of cement per cubic yard of concrete mixture is more than ample for strength. Use the concrete mix as dry as it possibly can be worked; excess water reduces concrete strength. Tamp or work the mixture well to remove voids and air pockets. Tap against the side of the pad forms to remove voids in the side wall.

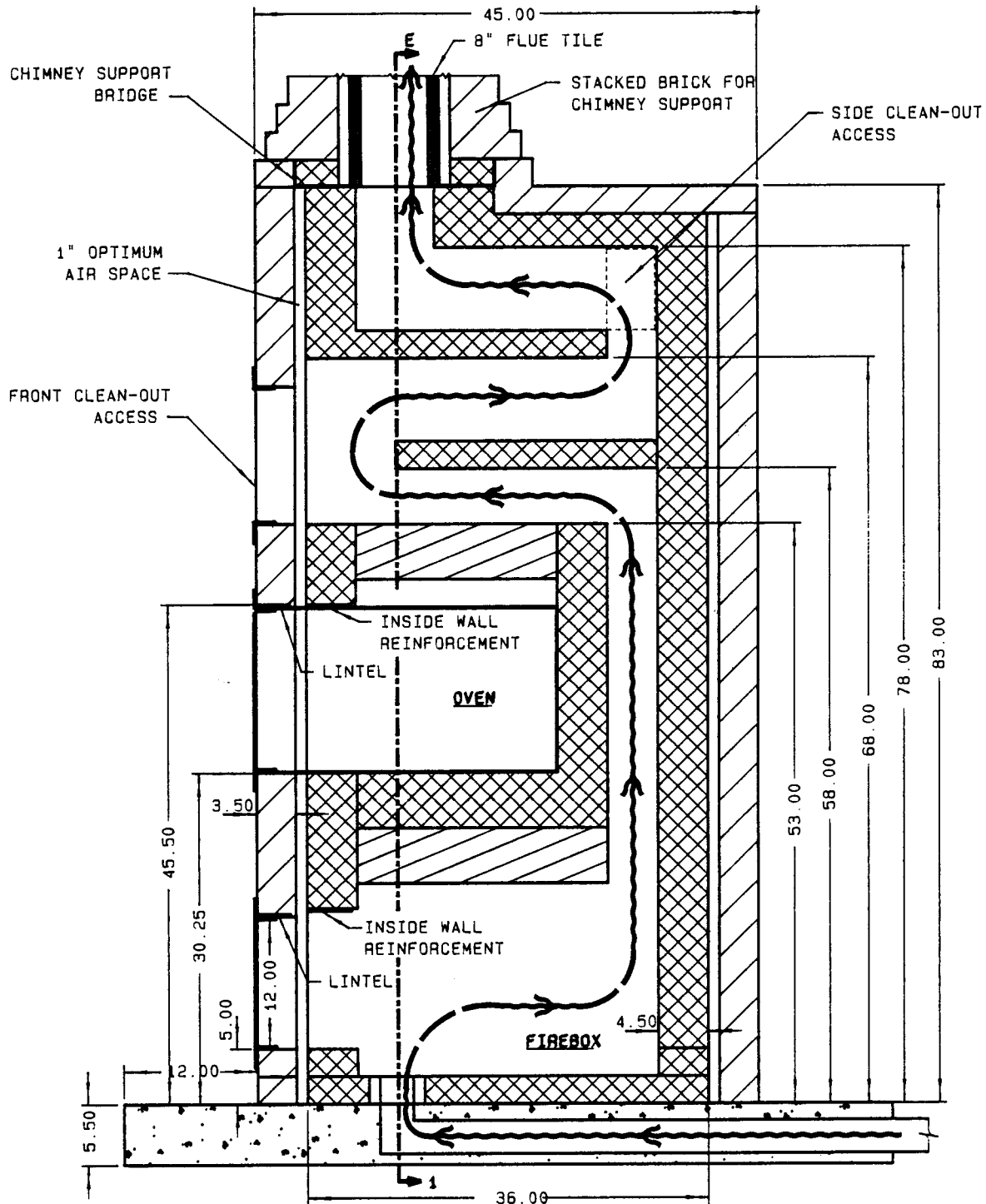

**MASONRY STOVE WITH OVEN**  
 RIGHT SIDE ELEV. SEC. E-2

### Combustion Air:

Whenever possible, outside combustion air should be delivered directly into the firebox by insulated air ducts that have full flow valves which will totally block air flow when the masonry stove is not in use. Any combustion heat device will consume oxygen, which normally comes from outside air. If the outside air is not supplied by ducting, the air must be drawn through the house by way of air infiltration around doors, windows, reverse flow in other vents and any other cracks that exist in a house. Air infiltration is especially high where the walls meet the floors. In the winter, any air moving through the house will be colder and dryer than normal house air and since it is moving air, it will cool body temperatures faster than calm air and one feels uncomfortably cooler, even at a warmer inside temperature. A primary reason that the English style fireplace is so inefficient, is because it consumes 7 to 10 times more air than is necessary for maximum combustion.

### Combustion Air Intake

Combustion air can be supplied using three 1 1/4 to 1 1/2 inch galvanized water pipes. Water pipes have been used in a fireplace for two heating seasons without visible problems. Lighter duty pipe could probably be used. While this small water pipe has worked, the air volume supplied is not adequate for the size masonry stove that is dictated by the use of standard 4 1/2" x 9 x 2 1/2 inch firebrick which results in a firebox of 18 x 27 x 12 inches. Two 3 x 3 inch square metal downspouts total 18 square inches and should provide adequate intake air. The downspout metal projecting into the firebox will eventually corrode out. The extension of the metal spout into the firebox serves to help keep ashes from entering the air tube. Short insert nipples could be adapted later for replacement if proven desirable. Electric conduit tube could be used for air ducting and also costs less than water pipe.

### Cross-Sectional Area of Selected Size Pipe and Ducts:

3 x 3 inch square pipe	=	9.00 square inches
3 inch round pipe	=	7.00 square inches
2 inch round pipe	=	3.14 square inches
2 1/2 inch round pipe	=	4.90 square inches
1 1/2 inch round pipe	=	1.76 square inches

Maximum suggested air intake area is 18 square inches via outside ducting. Each duct should be ten feet or less in length, longer lengths produce friction of the air flow reducing air volume in the firebox. If a longer run is required, increase the duct size from outside up to the air distribution box referred to in the next section.

During the fire start-up period, the air damper on the fire door can be left open so that some inside (house) air can supplement the combustion until the fire dies down to a level that can be supplied by the outside air tubes. This time span is an experience factor and depends on fuel moisture, outside air temperature and volume of fuel in the firebox but usually takes less than one hour.



## Combustion Air Valve or Distribution Box

The valves inside the house for the combustion air tubes can be regular full flow gate valves when using standard size galvanized pipe. Caution: Do not use globe valves because they greatly restrict the air flow. Intake pipes or tubes should be insulated from the outside house wall up to the valve inside the house to reduce heat exchange between inside and the outside. Where 3 x 3 inch downspouting or other type tubes are used the builder/crafter will have to design an insulated guillotine or insert valve substitute. Provisions should be made for partial valve closure, as opposed to only fully opened or fully closed positions. Use of a valve distribution box will enable one valve to control the air flow as opposed to a valve for each tube.

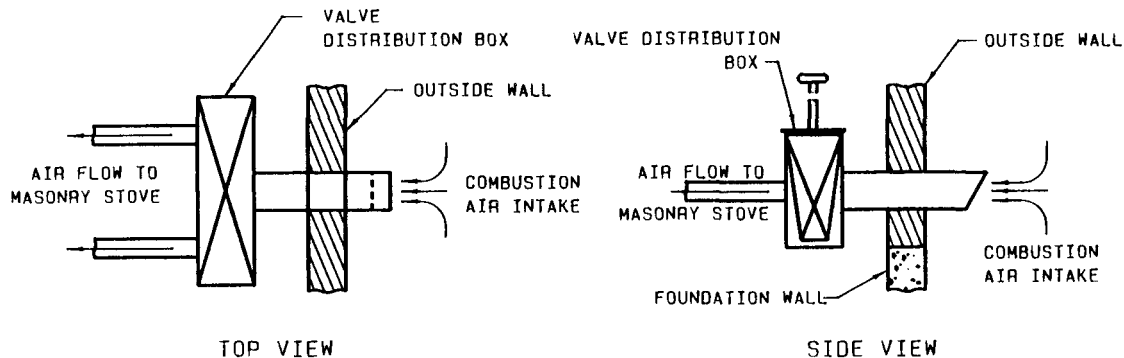

Insect screen ( $1/8 \times 1/8$  inch hardware cloth) should be installed over the outside openings to avoid entry by rodents, insects, animals or trash. Buy enough wire for the insect screen and screening of the sand for the ornamental brick mortar mix. The screen on the air duct should be removable to aid in duct clean-out if something accidentally falls into the air tube. The surface area of the wire screen should be twice the area of the tube. Avoid water entry into the air tubes by down turns or by reverse angle cuts.



## Brick and Mortar Suggestions

Brick and mortar should be selected both for ornamental value and resistance to high temperature. Use fireplace quality (or better)  $4\frac{1}{2} \times 9 \times 2\frac{1}{2}$  inch firebrick and high temperature firebrick mortar for the firebox. This quality brick must be carried throughout the firebox structure, including the oven and first flue run. After the first flue run, standard face brick or common brick and sand mortar has been used with no apparent problems. Standard brick and sand mortar is lower in cost than firebrick and firebrick mortar but will add some difficulty to construction details. For this reason our drawings are based on firebrick throughout the firebox, the oven, the flue runs and into the first few inner (filler) bricks of the chimney. Caution: consult your supplier on details for handling the mortar and avoiding air bubbles between bricks or possible freezing when using air setting high temperature mortar. Firebrick mortar is normally applied as a very thin coat with a paintbrush and each brick slides (scrubs) into place to eliminate air bubbles.

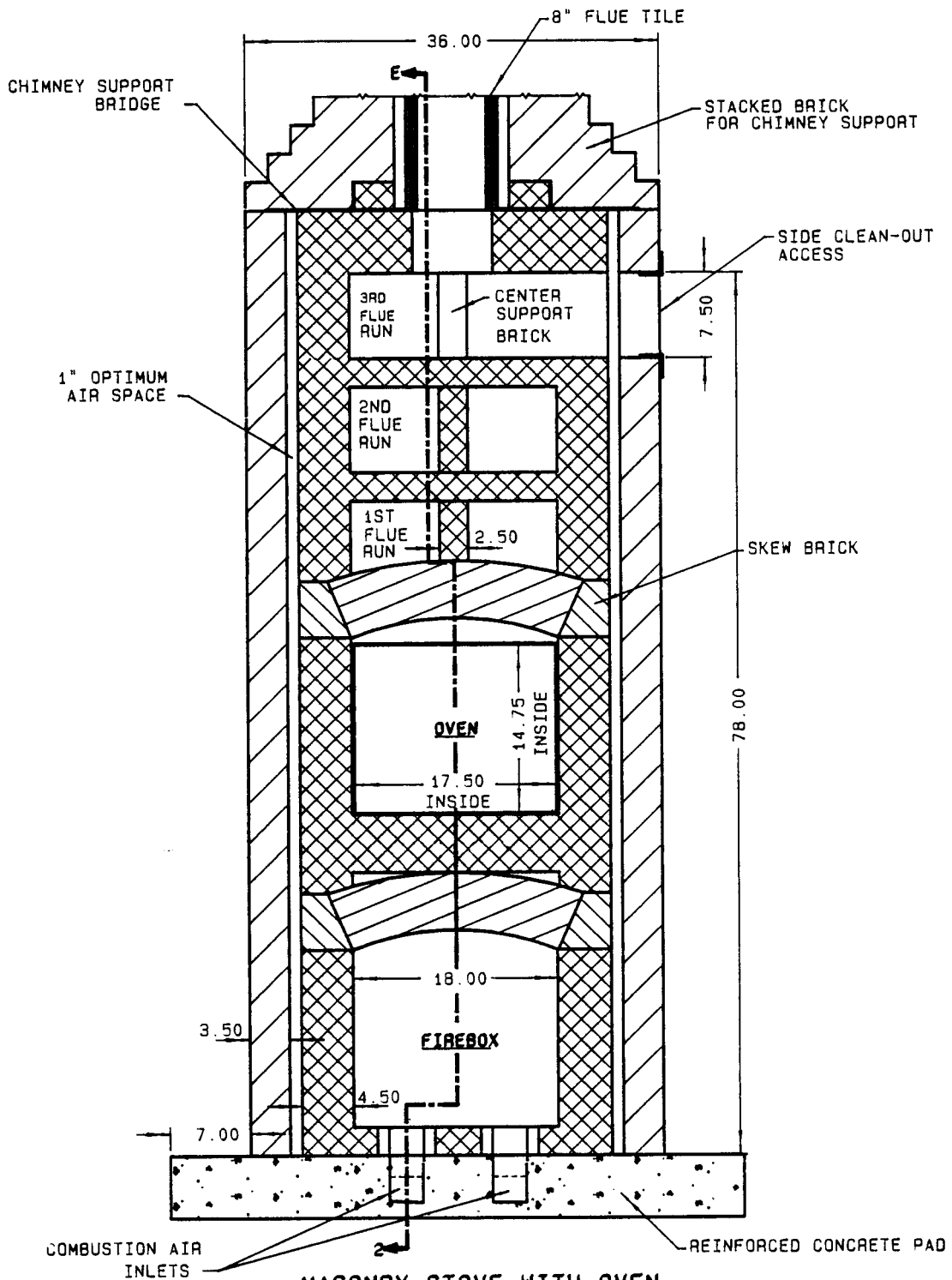

MASONRY STOVE WITH OVEN  
 FRONT VIEW ELEV. SEC. E-1

For the exterior (safety) ornamental wall, any type brick or stone will be satisfactory. Only a very limited area of this exterior wall will rise above 140 degrees Fahrenheit (the area near the primary flue exit at the rear of the firebox may be hotter). Select masonry materials which can withstand the temperature without cracking. Since the outside wall will be viewed by the home owner, your own imagination and preference will be a primary factor in choosing materials. These exterior walls have been constructed of ornamental stone, common brick, adobe, face brick, concrete with ceramic tile, or any combination of materials. Regardless of the base materials selected, the mortar should be mixed from clean sand screened through an 8 x 8 inch mesh screen. Do not use sand screened through 1/16 of an inch or smaller mesh. Do not use more than ten (10) percent lime in the mortar and avoid Missouri river sand because it usually contains carbon impurities from coal. Ten (10) percent by volume, of fly ash in addition to ten (10) percent lime added to the cement sand mortar will help to make a smoother easier to handle mortar. A bag of cement weighs 94 pounds, ten (10) percent by volume of fly ash is about 10 pounds per bag. Anti-mortar setting materials are available at some concrete ready-mix plants to retard mortar set up, this slows the setting of the mortar (check with the supplier). Anti-setting material is not necessary with lime added to mortar. For the small quantity of mortar required, it may be best to use a pre-dried, pre-mixed mortar from a hardware store or lumber yard. Permanent colors can be added to the mortar at the time of mixing. Uniformity in mixing of materials is very important even for non-colored mortar. Avoid over-wetting the mortar because it will cause excessive cracking and shrinking. If the sand in the mortar is too fine or the mortar is too rich from cement the mortar will compress from brick weight. This will limit the height of the wall that can be laid in a given time period.

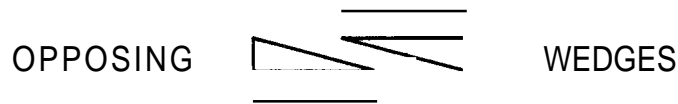

### Specialized Bricks:

Arch bricks are manufactured in several specific sizes. Consult your supplier on the exact number of each size and ask about the proper skew brick to be used to start the arch that spans the horizontal distance across the arch. It is best to lay out the bricks on the floor, draw a pattern and form a fiber board or plywood arch form, to support the arch during construction. The arch form should be precisely cross-leveled when it is set in the fireplace, by the use of opposing wooden wedges. The wedges aid in removal of the form after the mortar has dried. Always allow adequate drying time (24 to 48 hours) before removing the arch form and avoid cracking the arch.

In addition to arch brick, certain other specific size firebricks are available by special order. These often are handy in some places for filling spaces and spanning openings. They are more expensive than standard bricks but are usually worth the price when you consider broken bricks from attempts at cutting without ceramic saw blades. Cutting of bricks, even with proper equipment, is time consuming. Any saw blade used to cut brick should state its exact use in the label. Note that brick dust is destructive to the armature of portable circular saws.

### Flue and Chimney:

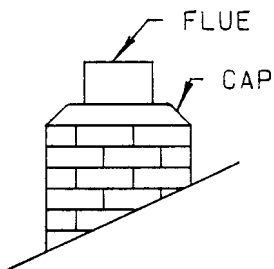

The flue tile should be 1 inch thick unglazed 8 x 8 inch square outside dimension or 8 inch unglazed round tile. Caution: Do not use glazed tile, it may crack from heat. Use high temperature mortar between flue tile joints. Because of the low temperature of the exit gas we suggest perlite or zonolite insulation in the air space between the flue tile and the brick chimney structure to retain heat in the chimney. Caution: do not overly compress the insulation. When capping off do not seal the cap to the tile (allowing for vertical expansion). Do not use concrete blocks for the chimney as they often soak up rain and may cause future chimney problems. Chimney top covers are not necessary except for extreme downdraft problems and to discourage birds and animals from nesting in the opening.

The heat baffles, in reality, are part of the flue (chimney) system. The horizontal baffles are separated from each other by bricks set on edge. The free flow passage of these flue (baffle) runs must be equal to, and preferably greater than the free flow passage of the flue tile. As an example, a seven inch (inside measure) flue has 49 square inches of free flow. This requires that a baffle run should have not less than 49 square inches of area after allowing for the space occupied by the supporting separator bricks. Also, as a rule of thumb, horizontal flue runs (baffles) should not be less than 27 inches long.

### **Avoid Downdrafts:**

Downdraft problems are best corrected by increasing chimney height or by pruning the tops of interfering tall trees. If all else fails, use a directional rotating type flue top cover to correct the downdraft. The flue top should be two feet taller than any roof surface that is closer than ten feet horizontal distance. It is best if the top of the flue is two feet taller than the gable peak. This avoids downdraft in most situations.

### **Damper:**

The unit described here is designed for complete air control, therefore a damper is not necessary. A chimney damper should be installed if air control is not complete. However, we know of some units that operate satisfactorily without dampers or air control valves but this will greatly reduce the efficiency of the fireplace.

### **Construction Time:**

Based on a workshop situation with no bricklaying experience, it will require about 7 to 8 working days to construct a masonry stove with hand mixing of mortar and using textured (striated) face brick for safety walls. Others have indicated five working days for construction is adequate. Experienced bricklayers may construct a unit in a shorter period. The walls must be plumb and cross-leveled at each brick course. Pre-mixed mortars and a perfectly leveled pad will reduce the construction time. The stove constructed in a Missouri workshop did not have an oven. The oven, as shown in this publication, and the extra arch will add to the time required (perhaps a few hours). The oven may be eliminated from this suggested design. Extra horizontal flue runs could be substituted for the oven if the oven is eliminated, or three vertical flue runs could be used. The oven is designed to aid in heat transfer to the room, reducing the normal 4 to 6 hour delay for the stove to begin adding heat to the room.

### **Doors and Cleanouts:**

Doors should be preselected to fit your taste and the size of stove you wish to construct. The firebox door should be cast iron or insulated 1/4 inch thick mild steel to avoid warping. Glass doors have been used successfully where the stove is not over-fired. There is one report of overfiring melting the glass door. Doors can be obtained through stove dealers, iron casting foundries, from used stoves or from a few specialty companies that manufacture custom designed doors or stove parts. Some welding shops should be able to make suitable doors. Caution: do not start brick work until the door and clean-outs are in your possession.

Cleanout doors can be standard fireplace cleanouts except at the primary flue exit from the firebox. A cleanout is not necessary in the primary flue. Cleanouts, round or square, can be purchased from local sources or made up by sheet metal shops as desired. Select cleanouts as small as practical. The use of smaller cleanouts will often permit avoiding the use of a reinforcing angle iron lintel. Four and one-half inch brick spans can be tolerated in most situations without reinforcing lintels. Consider the weight of the chimney placement in relation to the flue cleanouts when deciding if a steel lintel is required. Caution: In the design shown in this publication, with a front cleanout and the chimney resting on the front wall(s) a lintel is required, especially on the top run of a three run horizontal flue design. The vertical leg of the angle iron lintel should be on the outside of the firebrick wall and on the inside of the safety wall. If a steel frame is considered to be desirable, as a personal choice, as decor in the ornamental brick, an angle iron picture style frame can be fabricated. The drawing

included is a suggested size. Fabricate the frame to fit the chosen size of the cleanout. Do not use a welded frame in the firebrick wall because of potential cracking that may result from the heat expansion of the metal frame. Use only a lintel on the firebrick wall and allow one-fourth inch of expansion space on both ends. The lintel should rest on at least one-half of a brick length on either side of the opening (extend 4 1/2 inches past the opening). Remove all metal burrs and rough edges, allow the metal lintel to slide with heat expansion and **do not** use glue or mortar on the lintel. Use some non-sticking surface separators, such as a sandwich wrap or wax paper (both melt out), to avoid binding the brick to the metal.

### **Sealing the Cleanouts:**

To avoid smoke leaks, the cleanout must fit tight. One method of accomplishing a tight fit is to apply a thin layer of high temperature mortar cement to a dust free surface on the firebricks. Allow the mortar to become slightly firm, then slide the prefitted cleanout box into the opening and into the mortar as far as it will travel. Immediately remove the cleanout box, wipe it clean and allow the mortar to set for 24 hours before reinserting the metal cleanout box. This mortar sealing technique should be used in addition to a soft gasket in the expansion space between the walls.

### **Size of Unit:**

The masonry stove, as described in this publication, with a firebox exterior of 27 x 36 inches, is large enough to adequately heat a 1200 to 1500 square foot residence, when insulated to R30 ceilings, R20 walls and R13 floors. This also assumes good weatherstripping, joint caulking and double glazed windows. Heat distribution by directional fans or duct work will be required to adequately disperse the heat that this stove is capable of producing. Twenty pounds of air dry wood burned in a masonry stove will deliver approximately a net value of 112,000 BTU.

With the use of special sized firebrick or castable clay a vertical flue run masonry stove could be constructed with an outside ornamental wall dimension of 25" x 25" x 6 feet high. Allowing for safety spacing with a heat shield the masonry stove would occupy a space of approximately 39 x 39 inches. This is very similar to the space required for a large radiant heat style stove. The weight of the unit would also be greatly reduced. The cost factor is uncertain as fewer but more costly materials are required, also molds are required to form the castable clay.

### **Placement of Unit:**

To achieve its full effectiveness, the masonry stove should be placed entirely within the building envelope, only the air tubes and chimney should extend through the walls or ceilings. A masonry stove produces mostly radiant heat (similar to the sun on a clear day). Therefore, line of sight heating is the most obvious use of these units. The more open the structure and the more centrally located, the better the results.

### **Maintaining the Air Space:**

Do not allow excessive mortar to drop into and accumulate in the air space during construction. Temporarily use boards or rags loosely fitted into the air space to avoid mortar spilling into the space. If mortar does drop into the space, use a long rod or other tool for clean-up. This air space must be maintained for free expansion or the outside wall may crack.

**Gaskets:**

Doors and clean-outs should be sealed with fiberglass or other soft, non-asbestos, non-combustible materials to reduce leakage of combustion gases. Stove dealers often sell gasket kits. Do not overly compress the gaskets as heat expansion may occur. Rock wool insulation will work as a gasket material around doors and cleanouts, in the air space between the two walls. **WARNING:** do not use fiber glass from residential fiber glass batts or blankets for gaskets, binding material will break down from the firebox heat.

# Operating The Masonry Stove

## **Start-up Conditioning (after construction):**

Allow at least four weeks of 50 degree Fahrenheit (or greater) natural air drying, by opening the air tubes and the firebox door. Use of forced air or controlled low temperature heat will speed up the drying. CAUTION: rapid drying before burning may lead to cracking.

After air drying, the first fire should be light wood kindling with about five pounds of wood and enough paper for starting. Increase the fire size by two pounds of wood per day until twenty-five pounds of wood is fired on the tenth day. Then 50 pounds burned slowly on the 11th day will usually complete the conditioning time. This conditioning time is important. All of the construction moisture must be driven from the brick prior to high temperature firing to avoid surface cracking from trapped steam. Excessive cracking can allow some smoke to leak through the firewall into the house.

## **Loading the Wood in the Firebox:**

Put a small amount of paper and kindling near the rear of the firebox, then larger kindling, then small logs, and then larger logs. Use a long stick or other device to light the paper at the rear of the firebox. This allows a very hot fire and burns from the rear to the front without burning all of the wood at once. Rear to front burning will not overload the chimney and air ducts. A masonry stove works best when fired hot, if the chimney draft and air intake continue to provide a clean burning of the fuel. Generally, new wood added to the firebox will burn readily, without kindling wood, even if only a few hot coals are visible from the previous charge of fuel.

## **Operating (Controlling the Fire):**

The greatest probability for smoke to leak into the room is from 5 to 45 minutes after the fire is started. Do not open the door in this time period. Use the driest wood when starting a fire and do not overload the firebox. Be certain that the flue and the outside air vents are open. In very tightly constructed houses, a window or door may need to be opened for a few minutes at start-up when using the air damper on the fire door for start-up combustion air.

Avoid running an oil or a gas furnace when starting the masonry stove. This prevents a reverse flow of gases through the masonry stove to feed the flame on an oil or gas furnace. Anytime the masonry stove door or door damper is open, reverse air flow can occur because a greater negative force is created by the combustion air demand of a furnace. A combustion draft fan in an oil furnace creates an even greater negative force.

From a comfort point of view, it is very easy to overfire these masonry stoves. For example, 20 pounds of air dry wood will supply enough energy to heat a well insulated 1000 square foot home for 12-15 hours, even with a zero degree outside temperature. Since a masonry stove produces radiant heat, a person is more comfortable at a lower temperature when one is in the vicinity of the unit. The unit holds heat for a long time, therefore, overfiring should be avoided. Opening a window to cool the house after overheating, is not an efficient use of fuel. After the fire has died down, close any open windows, close the bell damper on the door, and regulate the outside air flow in the outside air intake tubes.

## **FuelTypes:**

Because the firebox temperature has been measured at 1800 degrees Fahrenheit, even fairly high moisture fuel will normally burn without a serious creosote buildup. However, high moisture content fuel will reduce the heating value of the fuel and therefore should be avoided. Repeated burning of overly wet fuels could possibly lead to creosote build up even in these normally creosote free masonry stoves.

The question has arisen about burning coal in a masonry stove, even though they are considered wood burning units. There is a lack of information regarding the use of coal as a masonry stove fuel, but in one known situation, roof shingles and building felt paper were burned without black smoke emissions or creosote. On the subject of burning coal, the following advice is offered; use a grate inside the firebox, because coal must have undergrate draft to burn properly. Coal also burns hotter than wood, therefore, use a very small fire to avoid structural damage to the walls of the unit. Do not try to burn coal under any circumstances if the firebox is not made of high quality firebrick and high temperature air setting mortar. Caution: Portland cement mortar will not stand high temperature and is not to be used with firebrick in the firebox or the first flue run.

When burning any fuel besides dry cordwood, burn the fuels only in small quantities and only after the firebox has reached an operating temperature which requires one to two hours of rapid burning.

When the firebox is at full operating temperature and properly supplied with air, all biomass is completely converted to carbon dioxide and water vapor. Both of these gases pass harmlessly through the flue runs. If the firebox is overloaded with high moisture or high energy fuel (tar, glue, etc.), there is a very great chance for overfiring and for creosote deposits in the flue runs and chimney liner, especially at start-up. Incomplete combustion from lack of sufficient air will waste fuel and create carbon monoxide gas. Overfiring will result in heavy smoke pouring out of the chimney. The fire (as seen through the door damper) will not be a good clear color, but will appear as a dull yellow to orange color. Ideal combustion usually results in blue and bright yellow flame. DO NOT burn CCA treated, Creosote treated, Penta treated, or painted lumber. Each of these wood preservative treating compounds can create long term health hazards because of toxic gas produced and/or heavy metal deposits from fly ash or flue gases. CCA contains arsenic, paints often contain lead, chrome, titanium and other undesirable compounds which become a greater hazard when gasified by burning.

### **Heat Distribution:**

The use of a small (3 or 4 inch diameter blade) slow speed fan, placed high on the wall in the same room as the masonry stove, aimed at the floor down a short hallway or through a doorway is a very economical way to distribute heat. Slow speed fans can usually be obtained at specialty stove dealer shops, hardware stores and/or some electrical supply houses. Non-ducted fan driven air may feel cool, even at 90 degrees Fahrenheit, but it will still warm an adjoining room. It is the evaporation of moisture from your body that makes the warm air feel cool. A forced air furnace usually blows air at temperatures higher than 110 degrees Fahrenheit.

In some residences, a furnace duct system can be utilized to move hot air, if there is a "fan-only" operation in the furnace cycle, however, masonry stoves are best utilized for zone heating (one or two rooms). A masonry stove located in a well insulated basement (preferably insulated on the outside of the walls) is a reasonable way to distribute heat. However, a heating unit located in a non-insulated basement is a very poor way to distribute heat.

### **Safety:**

It is suggested that a minimum clearance of twelve inches from the exterior side wall of the masonry stove (27 x 36 inch exterior size firebox) and a minimum of 18 inches from the rear of the exterior wall to the nearest combustible material be maintained. Larger masonry stoves may require more clearance. Dry wall, or a four inch brick against a wood stud, is not fireproof construction. If, for any reason this clearance cannot be maintained from the wall surface, it is suggested that a 26 or 28 gauge (light colored) sheet metal heat barrier between the house wall and the exterior masonry stove wall be installed. This heat barrier must have a minimum one inch opening at the top, bottom, and sides for free air flow. It must be spaced one inch out from the combustible surface, installed with non-flammable spacers, such as metal tubes or ceramic insulators. This should be a sufficient safety factor to allow a six inch distance between the heat shield and the exterior masonry stove *side* wall. Do not place the exterior *rear* wall of the stove closer than nine inches to the properly spaced heat shield. The heat shield should always extend six inches higher than the stove wall, or to within one inch



of the ceiling, whichever gives the greatest protection and allows unimpeded air flow. In a horizontal flue run design, the top of the masonry stove is that coolest part of the unit. Even with this design, maintain at least one inch of air flow space to a combustible ceiling surface. If the unit is not too tall, one extra brick, on top of the stove overlapping the previous mortar joints will greatly reduce any fire hazard. Temperatures at the top rear of a vertical flue run design masonry stove, are hotter than the same location with a horizontal design flue run. If it is anticipated that the masonry stove top will be very close to the ceiling, install a heat shield with the proper 1 inch spacing for air flow and sufficient spacers to avoid sagging. The fire door should be twenty-four inches from a combustible surface. If installed in an alcove, add 50 percent to all minimum distances as noted above.

Do not open the door when the fire is within 45 minutes of start up time. Do not open the cleanouts until after all coals and ashes have been removed from the firebox. Always place coals and ashes, even if they feel cool, in a metal container with a metal lid. Remove the ash container from the living quarters and place the metal container on a noncombustible surface. Fires have started as long as seven days later from supposedly cool ashes. Embedded coals within "cool ashes" often give off poisonous carbon monoxide when allowed to remain in the house.

In the event of a chimney fire, have a 25 pound, dry type, fire extinguisher nearby. Call the fire department immediately, evacuate all non-fire fighters from the house. Open the fire door and direct several short bursts from the extinguisher at the base of the fire. Close off all air possible. Do not use water on the firebox walls. Always have a knowledgeable person inspect the chimney after a flue fire. Smoke alarms are excellent low cost insurance; use them for the family's protection.

### Installation of Gas Port for Safety:

(On vertical flue stoves, it is a good safety measure to allow a 1 inch by 2 inch gas escape port at the top of the hanging flue run.) To avoid any explosive gas build-up that may arise because of improper stove operation, such as burning the fire too slow, or closing down the stove too soon or improper damper operation.

For placement of gas port see drawings below.

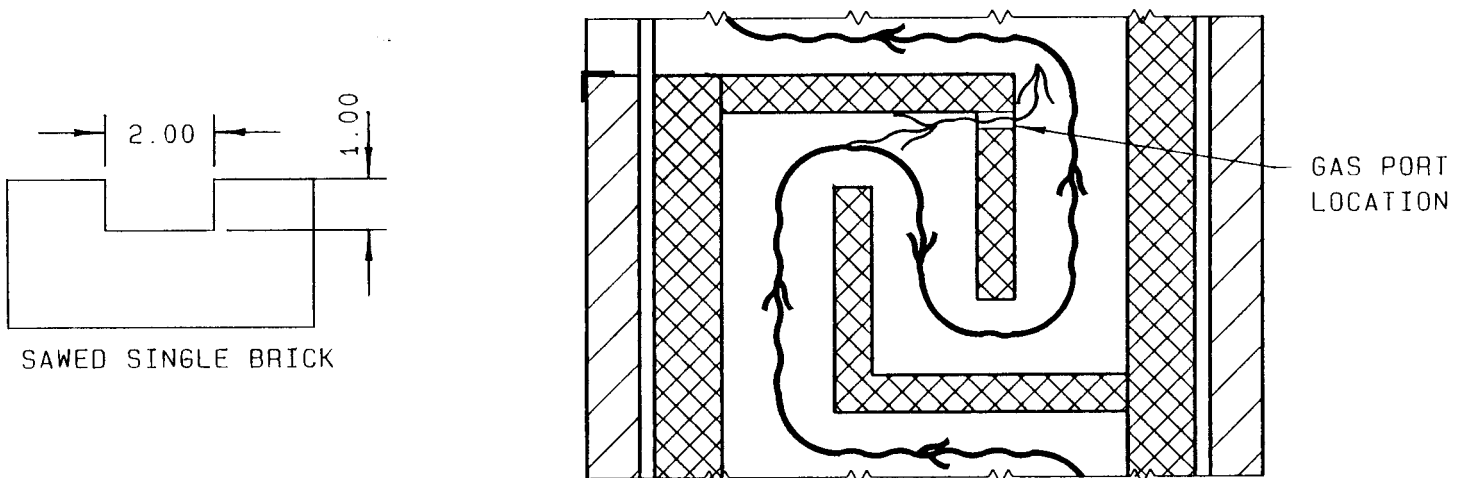

It is best to have the 2 inch line lying on the horizontal. The gas port should be at the highest point in the hanging flue run.

**Builder/Crafter's Confidence:**

There is a great deal of information to absorb from the previous pages. The volume of material may discourage some from attempting to construct a masonry stove. Once the materials are located, the greatest obstacle has been removed. Bricklaying is not complicated, just different and slower than carpentry work. Masonry stoves have been built at many locations around the country by do-it-yourselfers without previous bricklaying experience. However, it is a feasible idea to have help by setting up your own workshop group, or attend a workshop if one can be located. As in most unfamiliar situations, nothing is accomplished, unless something is started. If you are unsure of your skills, consult a brickmason or other competent crafts person. Locating materials may be difficult, but there are many sources of technical help for design and construction details.

**Addendum:****References:**

“The Practical Handbook of Concrete and Masonry” by Richard Day from Arco Publishing Company, Inc.; 219 Park Avenue South; New York, New York 10003, and also “The Art of Bricklaying by J. Edgar Ray; Charles A. Bennett Company Publishing, Peoria, Illinois. Your public library often has books on this subject matter.

**Materials List:**

Sand  
 gravel  
 reinforcing rods  
 tie wire  
 8 x 8 hardware cloth  
 Type A-1 portland cement, lime and/or anti-set compound, fly ash  
 angle iron or other lintels  
 clean-out doors, fire door, oven door  
 fire brick, standard and specialty brick, skew brick  
 air setting high temperature mortar (approximately 100 pounds)  
 fire brick grout (for filling and leveling by mixing with firebrick mortar) (grout is finely chipped firebrick)  
 face brick  
 anchor bolts  
 gaskets  
 flue tile liner  
 air ducts  
 air valves  
 sand screen-home made with 8 x 8 hardware cloth  
 flue damper (if needed)  
 2” x 6” forming boards for hearth pad form  
 12 or 16 penny common nails  
 roof flashing, roof cement and zinc nails  
 clean water for mixing cement  
 ornamental tile and mastic (if desired)  
 1 x 2 or 1 x 3 lumber (to build sand screen) plus wire for insect screen  
 reinforcing rods  
 welded wire fence mesh 2” x 4” and tie wire  
 doors and cleanouts  
 air ducts and valve materials

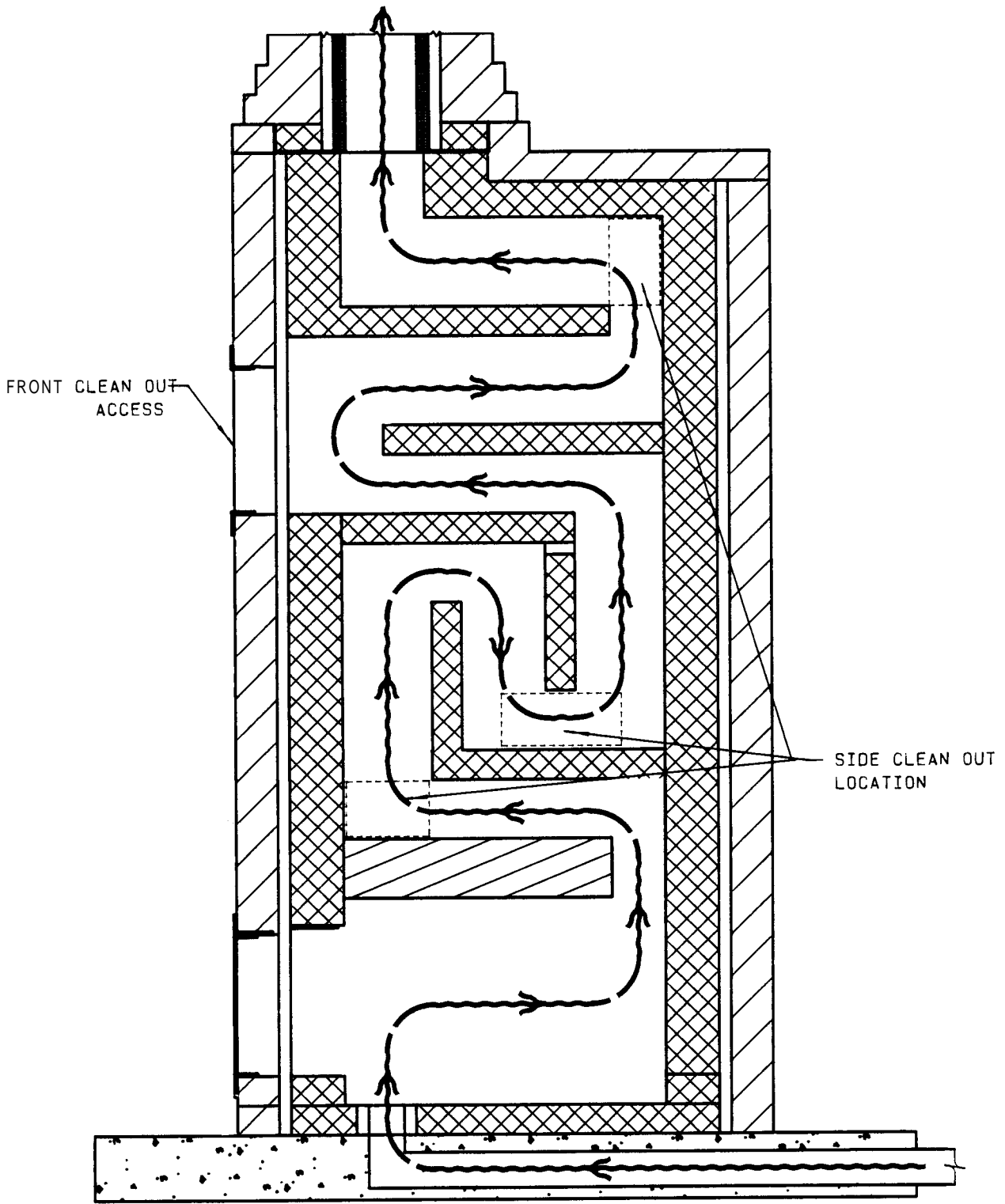

MASONRY STOVE WITHOUT OVEN  
VERTICAL FLUE RUN

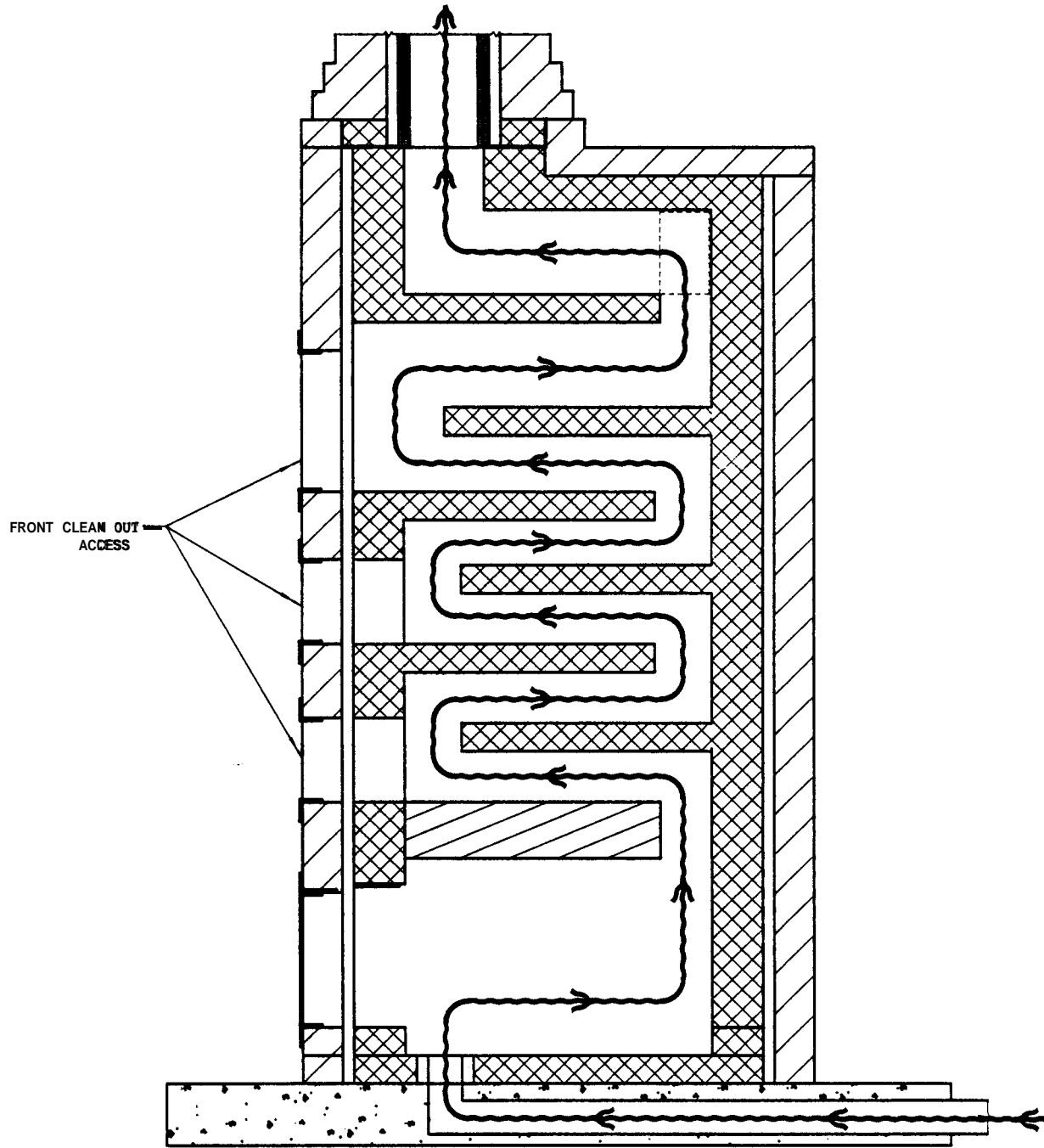

MASONRY STOVE WITHOUT OVEN  
HORIZONTAL FLUE RUN

When cleanouts are placed low in the structure, the support bridge for the chimney may be eliminated.

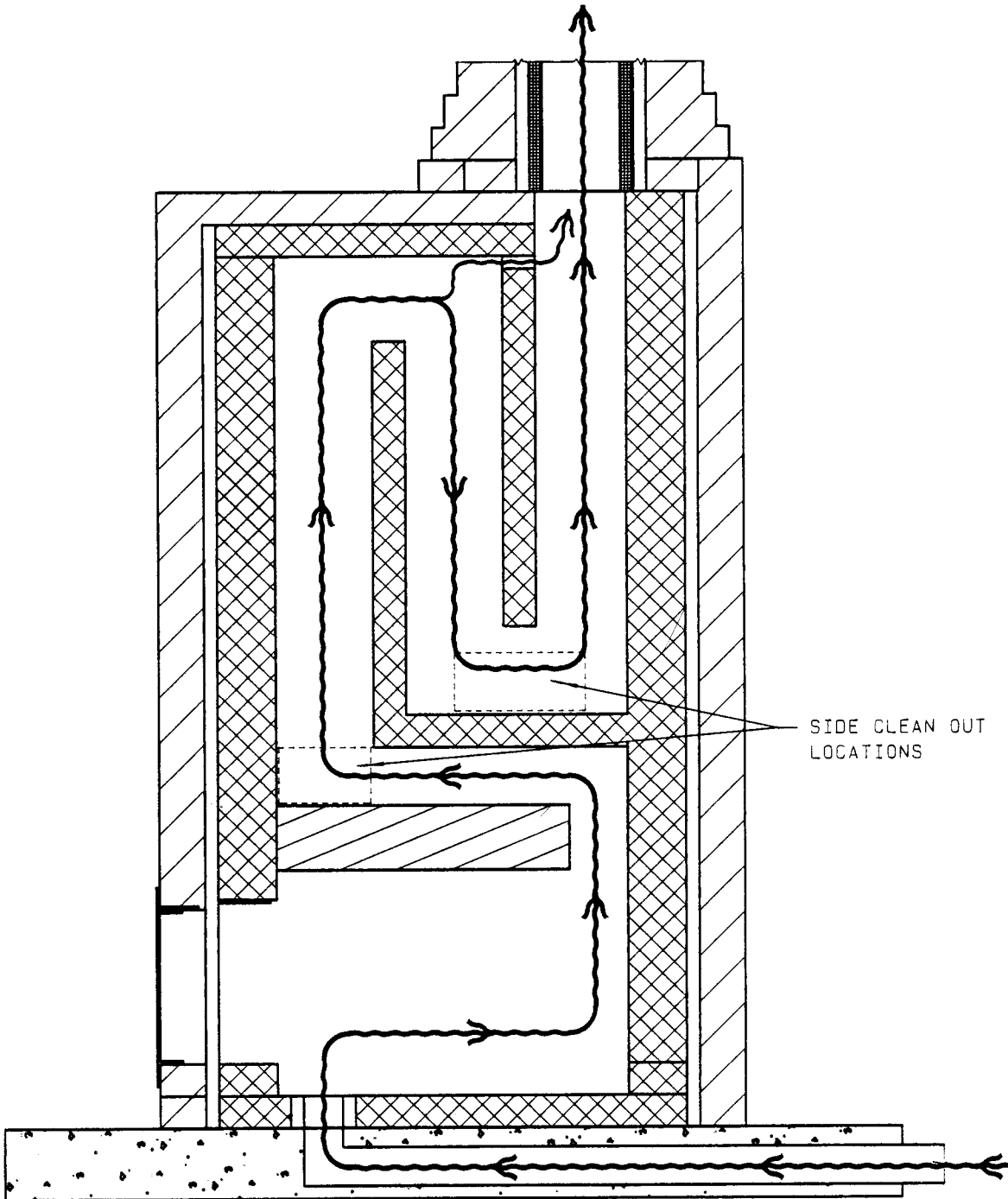

MASONRY STOVE WITHOUT OVEN  
VERTICAL FLUE RUN  
WITH REAR CHIMNEY

**Tools Required:**

brick hammer or masonry chisel  
ceramic circular saw blade (optional)  
carpenter level and line level  
chalk line  
trowels  
tuck pointing tool(s)  
masonry drill bit and wood bit  
carpenter rule  
brick rule (or marked board)  
arch form and wood wedges  
droplight and clamp  
mixing trough or board  
container for grout mixing  
paint stirring tool  
electric drill (**3/8"** min)  
hacksaw and metal file  
saw horse or elevated platforms  
**3"** and **4"** paint brushes  
cotton gloves (to avoid skin rash)  
screen for sand  
heavy pencil and note pad  
carpenter saw and keyhole saw  
hammer

Note: Anything forgotten on this list that might be needed?

For further details contact the Missouri Department of Natural Resources, Division of Energy, phone **(314) 751-4000** or write to P.O. Box **176**, Jefferson City, MO **65102**.

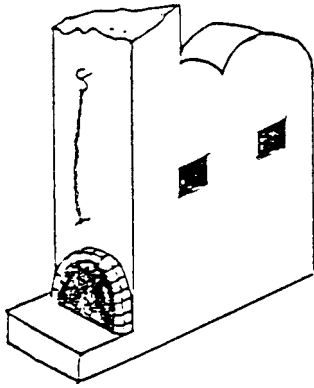

WILLARD

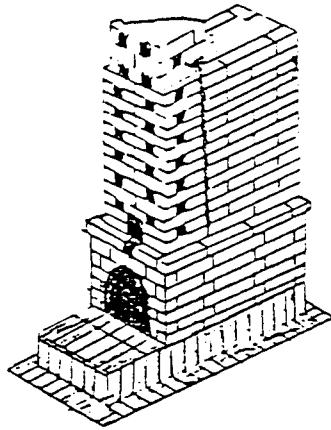

SANTA FE

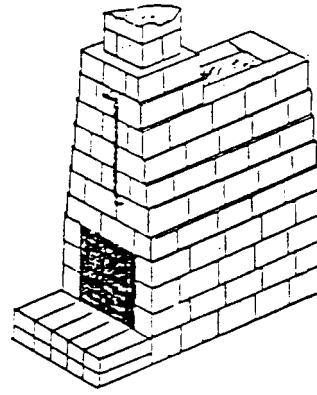

ROSWELL

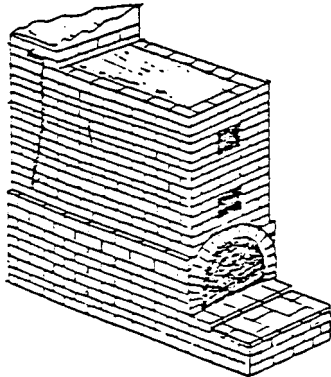

SILVER CITY

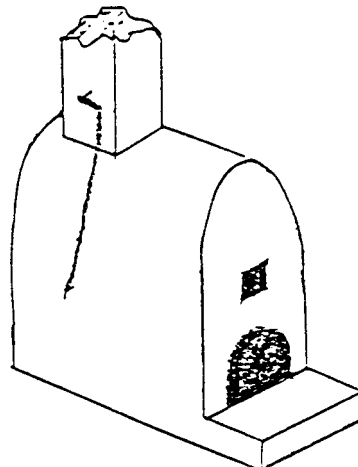

ALBUQUERQUE

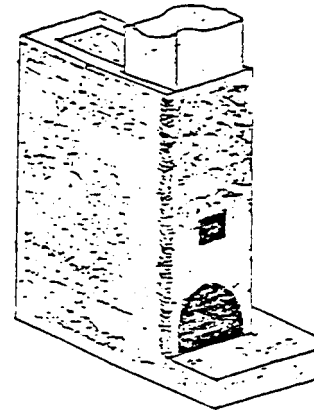

TAOS

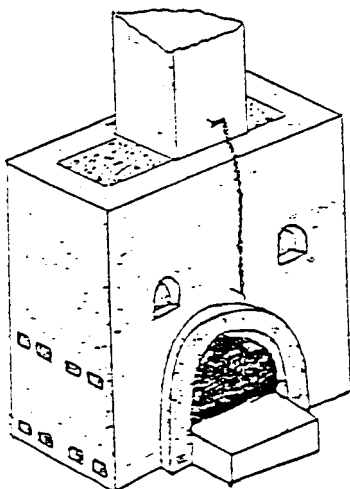

LAS VEGAS

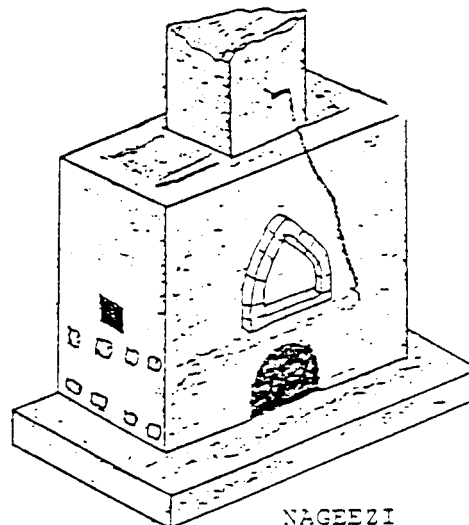

NAGEEZI

The array of masonry stoves above were designed and constructed by Jay S. Jarpe, during workshops and demonstrations throughout New Mexico. They show the side variety of designs and materials that may be used in masonry stove construction.

THE MISSOURI DESIGNED MASONRY STOVE

CONSTRUCTION DETAILS

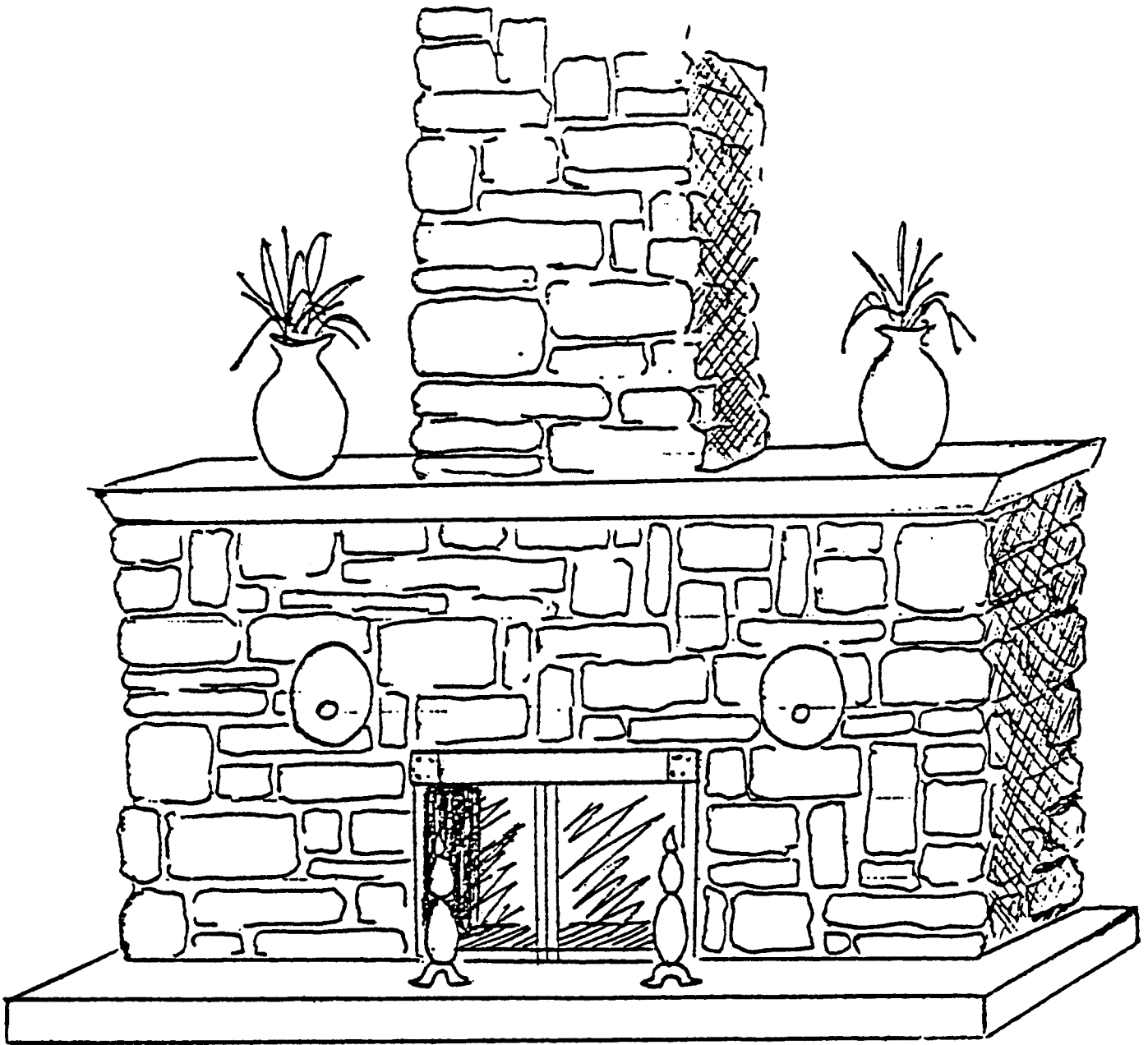

DRAWN BY  
SHIRLEY LENHARDT



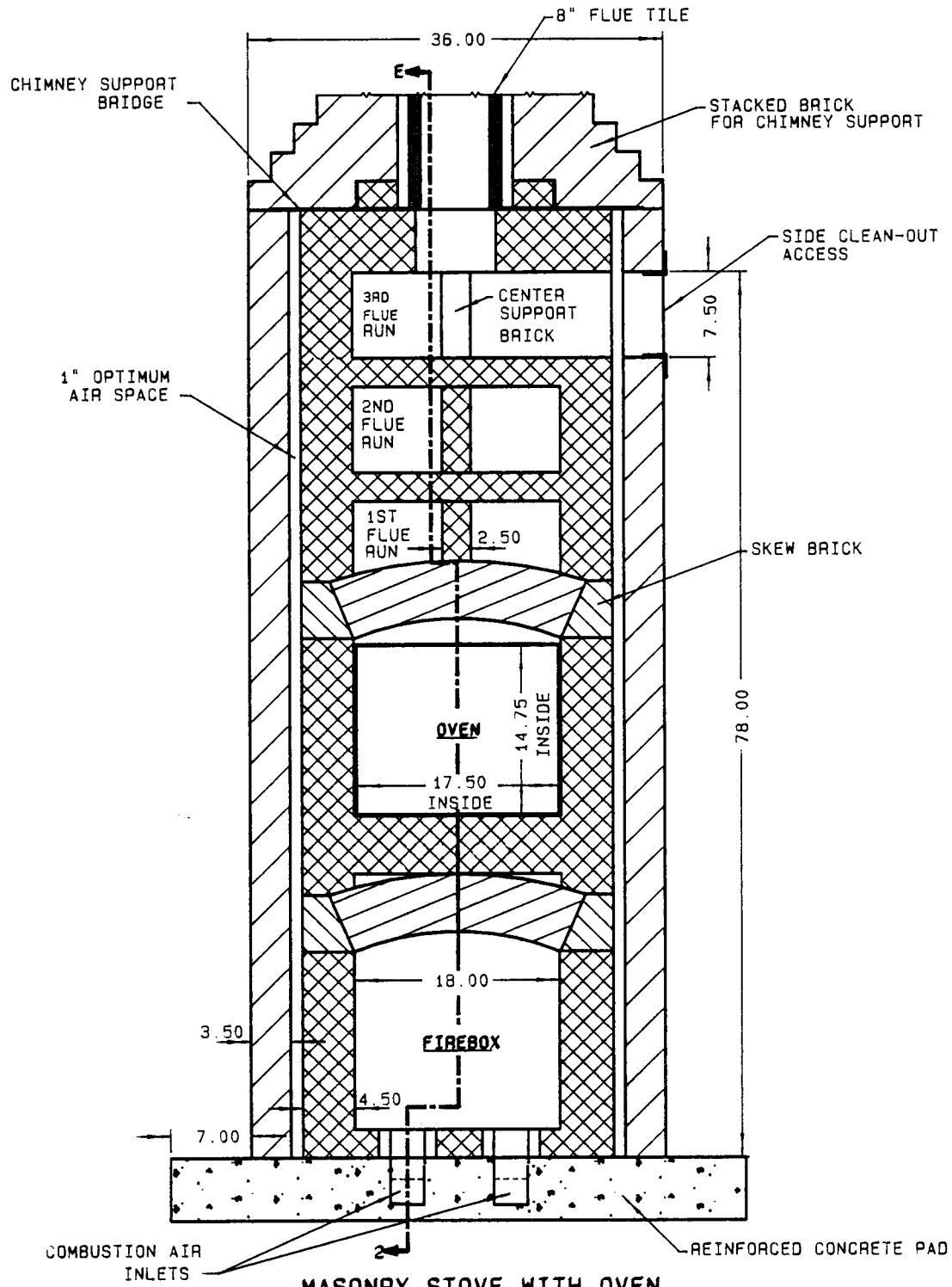

MASONRY STOVE WITH OVEN  
 FRONT VIEW ELEV. SEC. E-1

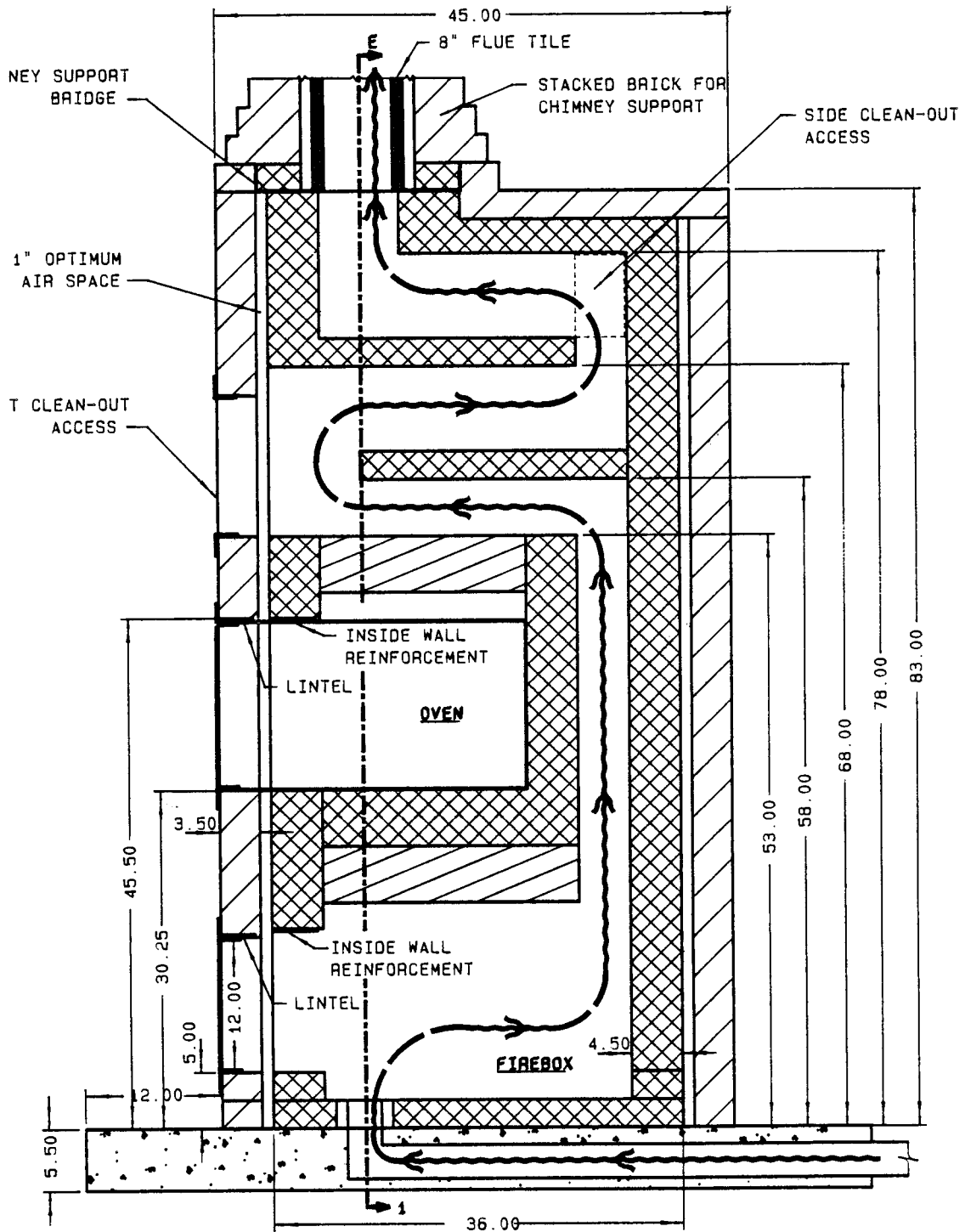

**MASONRY STOVE WITH OVEN**  
**RIGHT SIDE ELEV. SEC. E-2**

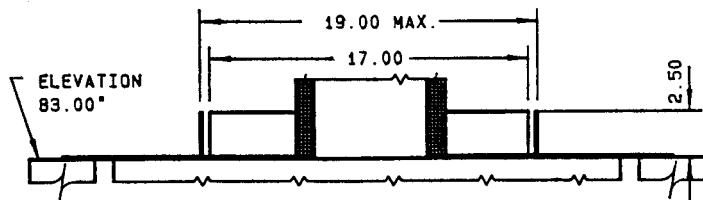
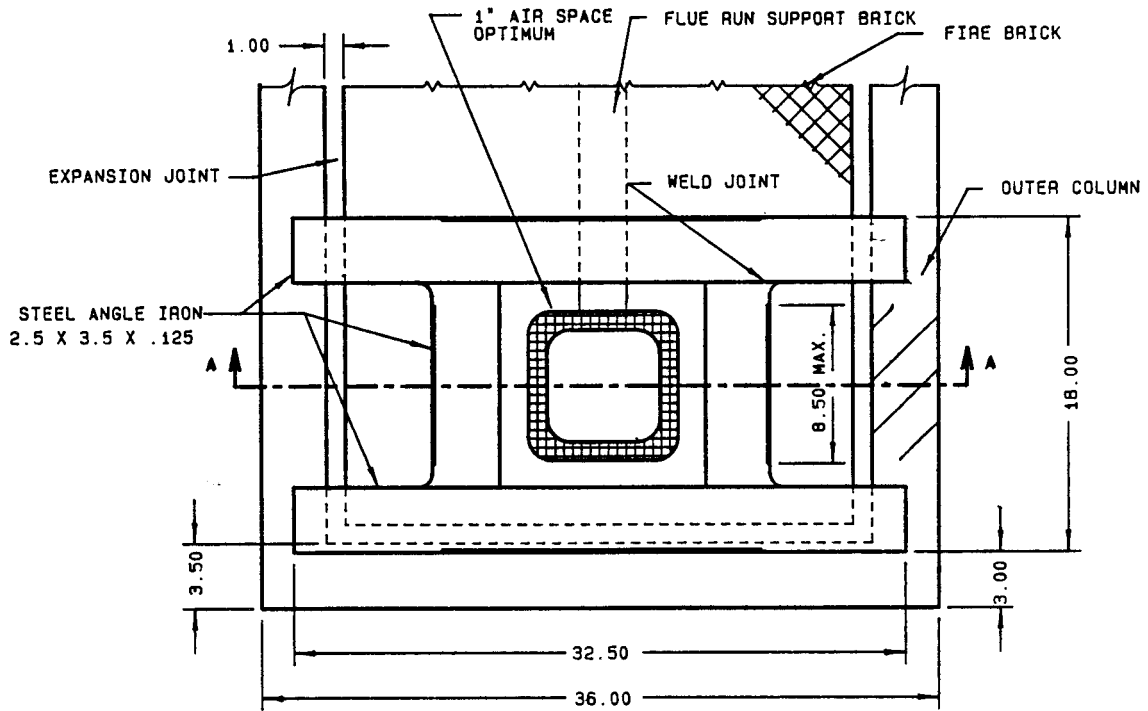
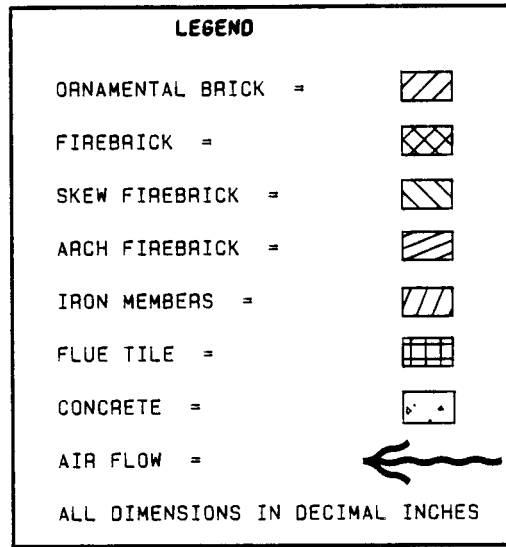

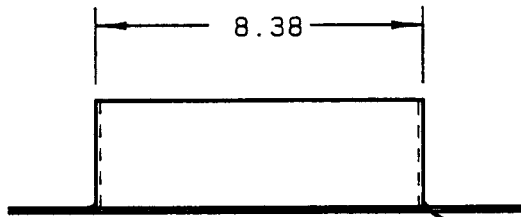

CONSTRUCTED FROM MILD STEEL  
 ANGLE IRON 2.50" X 3.00" X 0.125"

WELDED JOINT

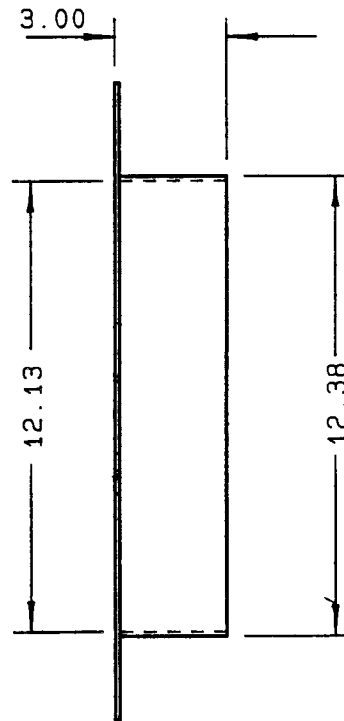
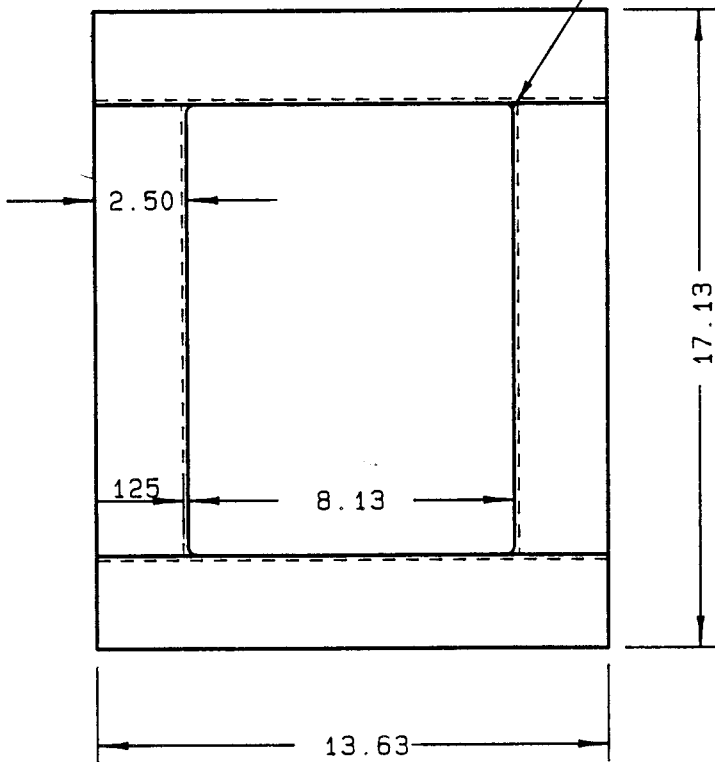

FRONT CLEAN-OUT ACCESS  
 DOOR FRAME (SUGGESTED)

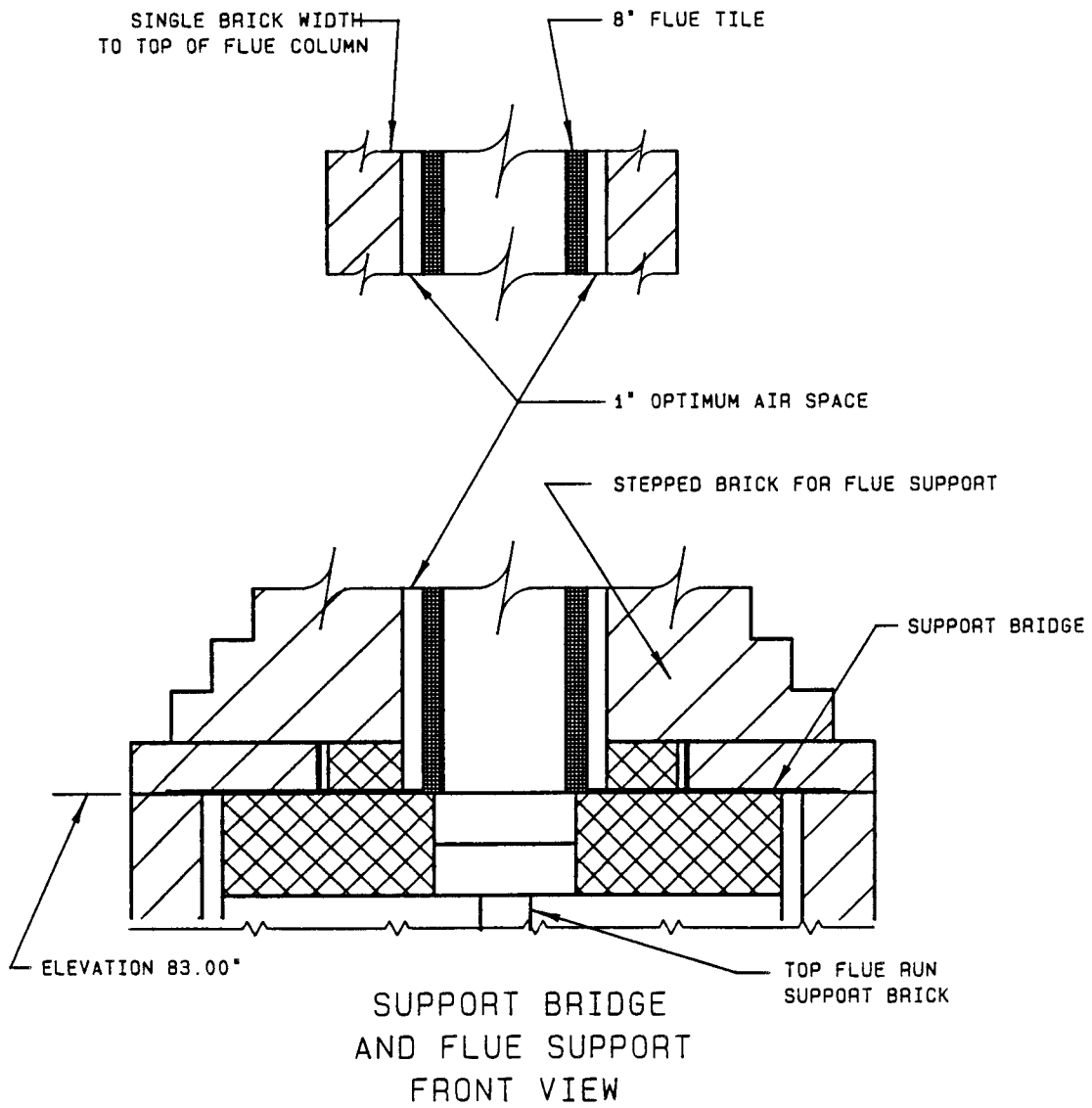

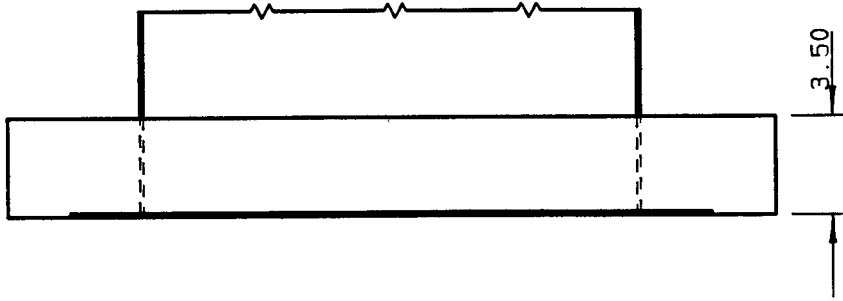

CONSTRUCTED FROM  
MILD STEEL ANGLE IRON  
3.50 X 2.50 X .125

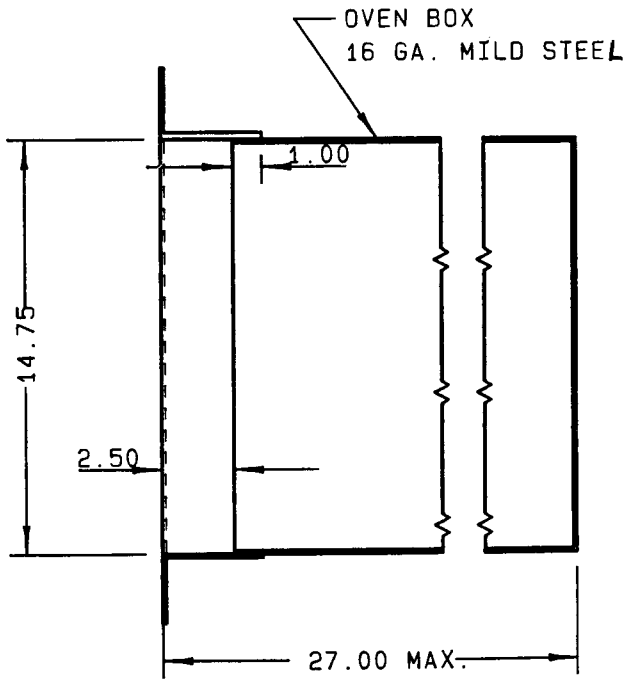
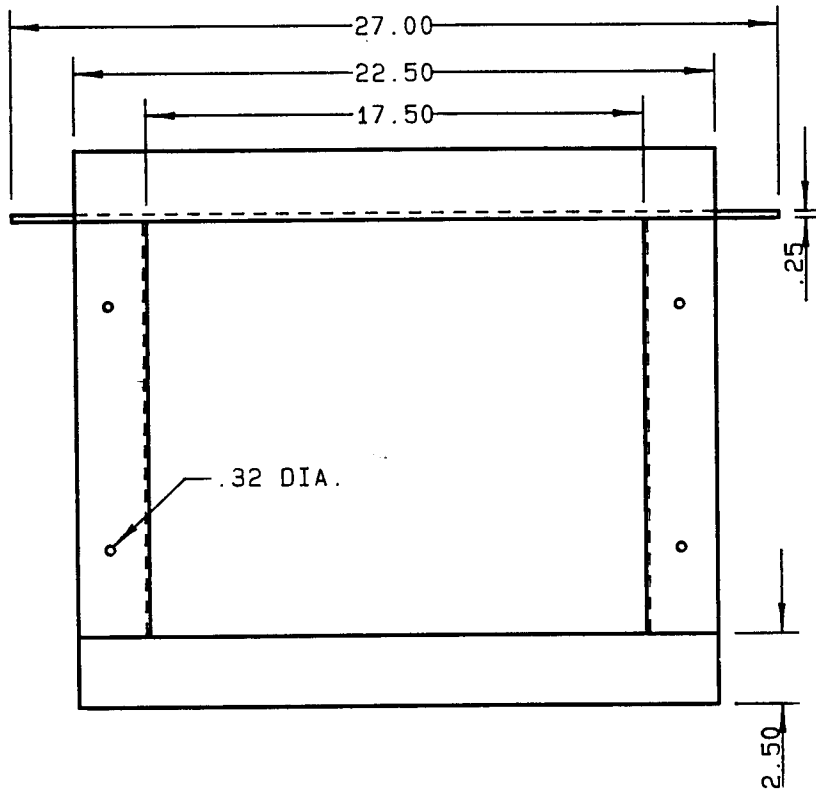

OVEN DOOR FRAME  
FRONT VIEW

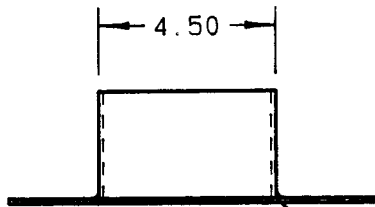

CONSTRUCTED FROM MILD STEEL  
ANGLE IRON 2.50" X 3.00" X 0.125"

SEE FRONT CLEAN-OUT DETAIL FOR  
ADDITIONAL DIMENSIONS

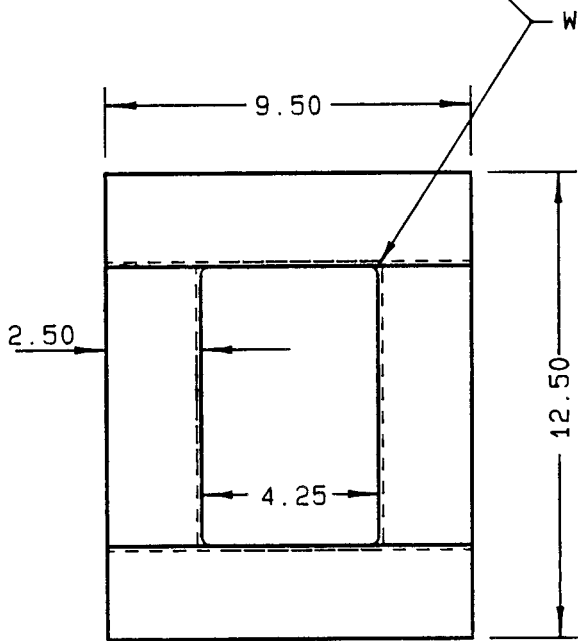

WELDED JOINT

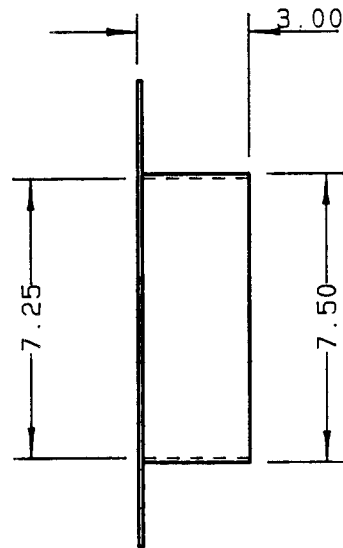

SIDE CLEAN-OUT ACCESS  
DOOR FRAME (SUGGESTED)

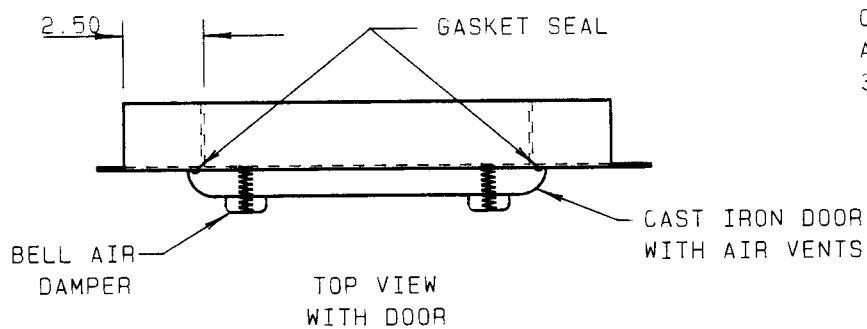

CONSTRUCTED FROM MILD STEEL  
 ANGLE IRON,  
 3.00 X 2.50 X .125

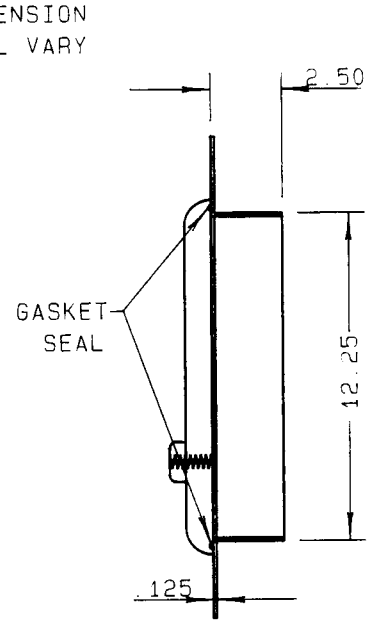
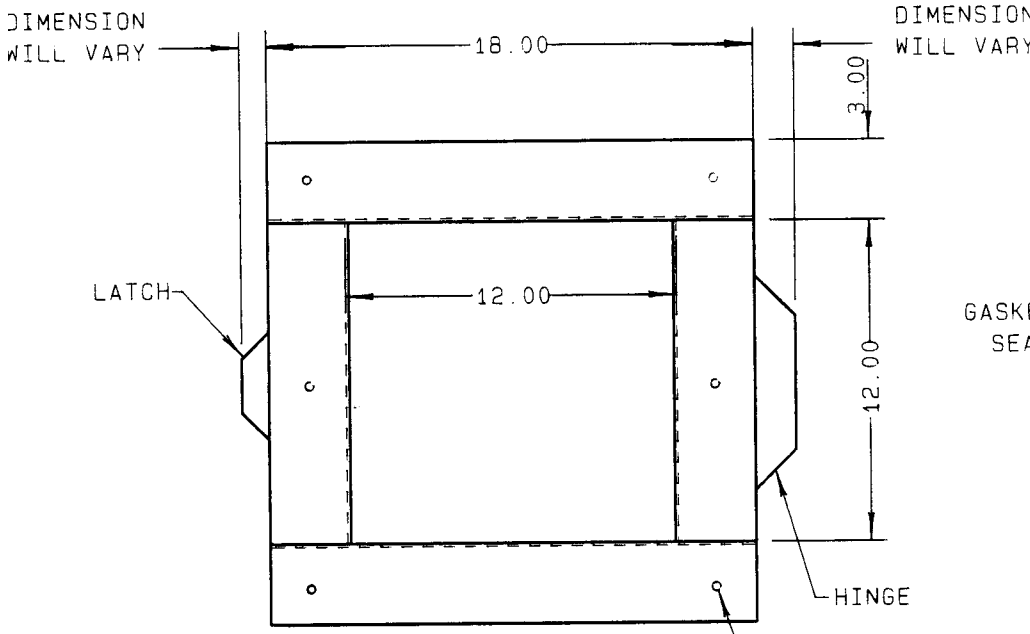

**FIREBOX FRAME**





